

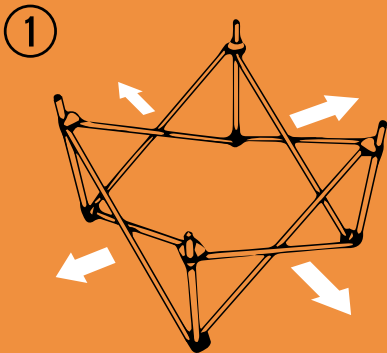

# POP-UP PIT

## CUSTOMER MANUAL

# ASSEMBLING YOUR POP-UP PIT



Open your Pop-Up Pit frame to its fully seated position.

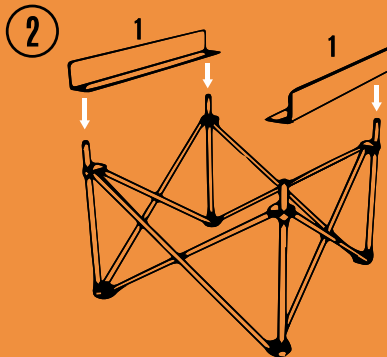

Pay close attention to which Ember Guard has the badge, this should be set aside until Step 3. Two Ember Guards should be placed on the frame parallel from one another. Guide the upright pole of the frame through the precut holes in the Ember Guards.



Your Pop-Up Pit frame may feel 'stiff' upon first use, this will subside after your first fire.



Your Pop-Up Pit will come wrapped with straps, keep these as they will aid in storage and packing in the future!

# ASSEMBLING YOUR POP-UP PIT

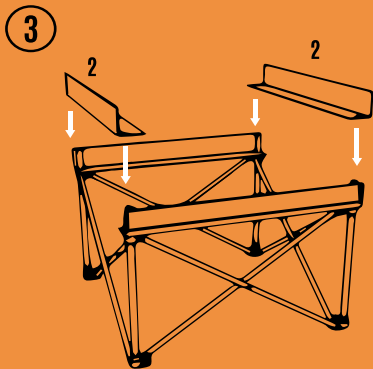

Repeat Step 2 with the remaining two Ember Guards. Note that the Ember Guard with the logo badge should be put on in this step.

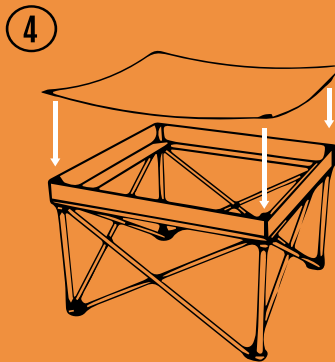

Holding the Fire Mesh with the folded edges facing down, each of the four grommets should be placed over the upright poles of the frame. Take care to not let any one corner drop too far down the uprights.

Once the uprights are through the grommets, slide the Fire Mesh down as one unit until the Fire Mesh is fully seated on top of the Ember Guards.



If you are having trouble applying the Ember Guards or Fire Mesh, WD-40 can be used on the upright poles for lubrication.

# DISASSEMBLY AND PACKAGING



## WARNING:

Ensure your fire is completely extinguished before handling or touching the Pop-Up Fire Pit!

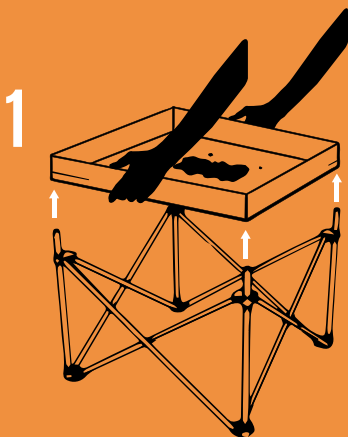

Remove the ashes from your pit. This can be done by either dumping the pit, using a shovel, or by removing the Fire Mesh. To remove the Fire Mesh look for the two bottom Ember Guards from Step 2 of the assembly. Simply place your hands in the middle of each Ember Guard and pull straight up keeping the Ember Guards parallel to the ground. This should remove all four Ember Guards as well as the Fire Mesh as one unit. The Fire Mesh can then be funneled, and the ash dumped out from it.

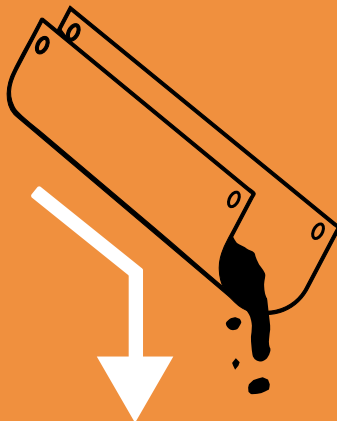
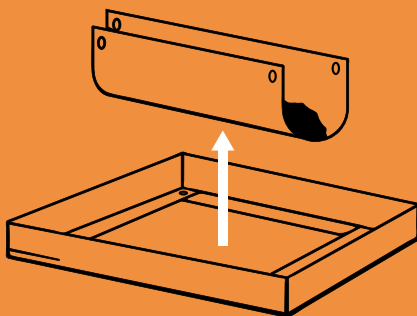

# DISASSEMBLY AND PACKAGING

2



Close the frame of the Pop-Up Pit and use the Ember Guards to form a box around the frame.

4

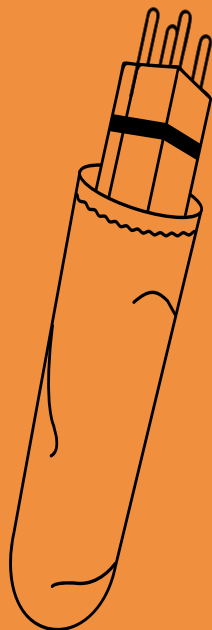

3

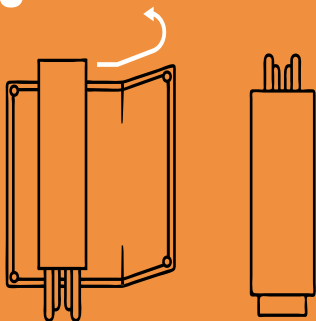

Place the Fire Mesh with the folded side up on the ground. Place the frame and Ember Guard construction on top of the Fire Mesh and roll together tightly. Repeat for Heat Shield if applicable.

Using the included straps, strap the top and bottom of the packed Pop-Up Pit to ensure the Fire Mesh does not uncoil. Place the Pop-Up Pit back inside its carrying bag, with the four poles from the frame towards the opening of the bag.

# HEAT SHIELD SET UP

1

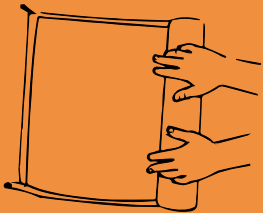

Unroll your heat shield

2

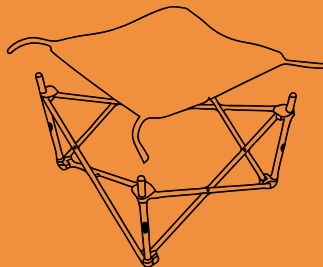

Place the heat shield reflective/shiny side up.

3

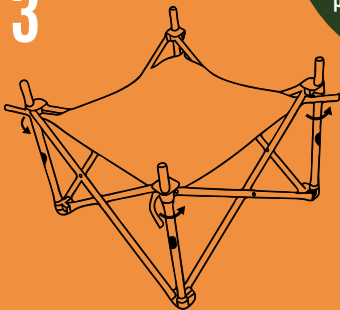

Wrap the high temperature velcro straps twice around the set screw 3 1/2-inches down from the Ember Guards in the frame poles.

4

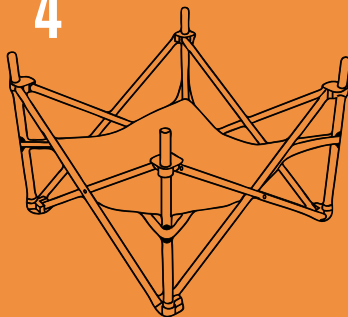

Push down the center of the heat shield and roll the edges to form a bowl shape.



There are more the 10 billion outdoor outings every year in the US alone. This can take a huge toll on our environment, be sure to pack out what you pack in and always practice 'leave no trace' fires.

# GRILL GRATE SETUP

---

1

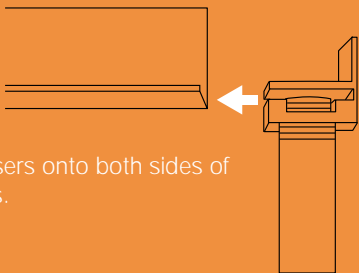

Slide risers onto both sides of the rails.

2

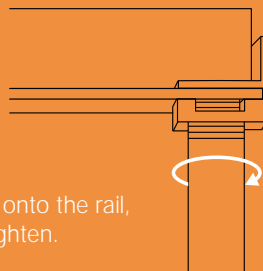

Tighten risers onto the rail, do not over tighten.

3

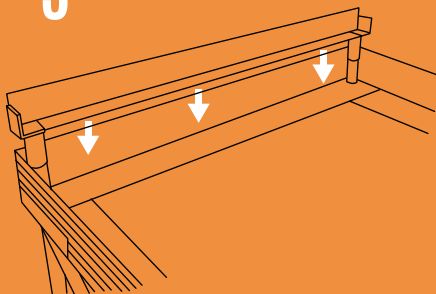

Slide rails and risers onto the mounting points in each corner of our Pop-Up Fire Pit.

4

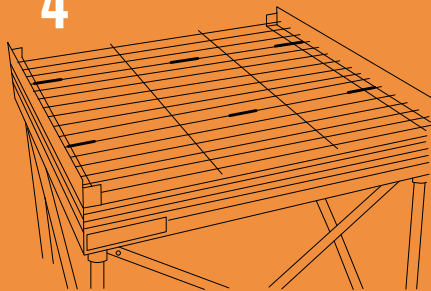

Unfold and place grill grates on top of the rails.

# CARE AND MAINTENANCE

---

Proper care is required to keep your Pop-Up Fire Pit performing optionally. Be sure to read all of these instructions carefully to ensure years of use out of your Pop-Up Fire Pit.

---



Fire Color changers should **NEVER** be used on the Fire Mesh, these will contaminate and cause irreparable damage to the Fire Mesh.

When ever possible, avoid the use of any flammable liquids as they may pass through the Fire Mesh and cause a fire hazard.

## FIRE MESH

Before packing up and storing your Pop-Up Fire Pit, you should ensure that all the ash is removed from the Fire Mesh. This should be done by rinsing the mesh after each use. Any excess ash left on the Fire Mesh may degrade the steel over a long period of time.

**Note:** Discoloration is to be expected after use, this is not removable.

## HEAT SHIELD

Ensure the heat shield is level with the 'X' of the frame cross members. Placing the heat shield too close to the Fire Mesh will cause damage.

**Note:** The heat shield is fire resistant and not fire proof.





# GRILL GRATE CARRYING BAG

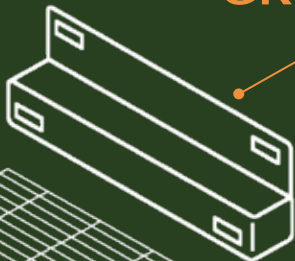

The vinyl carrying case can be rinsed with water and a light detergent to remove any grease or dirt that may have accumulated through use.

## GRILLING GRATES

Stainless steel grill grates tolerate intense heat and are rust resistant. It typically only takes a quick brush to keep them clean.

## EMBER GUARDS

Any soot build up can be removed by rinsing with a light detergent. A nylon brush may be used.

**Note:** Fires should always be kept at least 1" away from your Ember Guards to ensure proper airflow.

## POP-UP FIRE PIT

No additional care needed. WD-40 can be applied to contact points on the frame to ensure smooth opening and closing.

# ENHANCE YOUR FIRESIDE EXPERIENCE



## TRAILBLAZER FIRE PIT & GRILL

The Trailblazer Fire Pit & Grill is a mini-version of the full-size Pop-Up Pit. With a 12"x12" burn area, collapsible frame, & weighs 3-lbs making it the perfect companion for your next outdoor adventure.



## GROUND EMBER MAT

Use your Fireside Outdoor Ember Mat to keep popping embers and hot coals from damaging or polluting the ground around your fire pit, charcoal grill, or bbq.



## THERMAL PROTECTION GLOVES

These EN407 gloves are the perfect protection for your hands from flames & heat up to 932°F making them the perfect companion around your fire pit, BBQ/Grill, or kitchen.

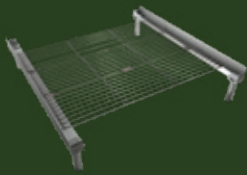

### TRI-FOLD GRILLING KIT\*

The Tri-Fold Grilling Kit converts your Pop-Up pit into a grill station. The stainless steel grates offer 350sq/in of cooking & fold way when not in use.  
\*Sold Separately

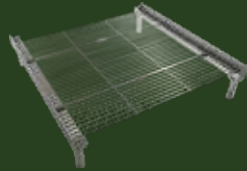

### QUAD-FOLD GRILLING KIT\*

The Quad-Fold Grilling Kit converts your Pop-Up pit into a grill station. The stainless steel grates offer 500sq/in of cooking & fold way when not in use.  
\*Sold Separately



### CAMPFIRE DEFENDER

Take control over our campfire! Cover your fire at the end of the night and safely keep your coals burning for 8-hours and wake up to hot coals in the morning!



### RENEW & REFRESH

Get fresh new pieces and parts for your Pop-Up Fire Pit. Available parts include the Fire Mesh, Heat Shield, Ember Guards, and the brand new zippered Pop-Up Pit carrying bag.



# LIVE LIFE FIRESIDE

There's just something about sitting around a campfire. People unplug and just appreciate the family and friends around them enjoying great conversations while enjoying tasty meals cooked over the open flame. The campfire is a source of light, warmth, and community. Gazing into the flames, we reconnect with our past and it reminds us of simpler times.

The campfire remains at the heart of any outdoor adventure, yet it has been overlooked as technology as advanced. Every year we see new tents, better sleeping bags, more comfortable chairs, and colder coolers. Everything around the campfire has been innovated with the latest technology, but the campfire remains the same, a hole in the ground that holds destructive capabilities.

Fireside Outdoor was created with a simple purpose in mind: Engineer products that make managing an outdoor fire easier and safer. With the help of innovative materials and a team of skillful engineers, we are creating common sense solutions to long lasting problems.

This manual will help you get the most out of your Fireside Outdoor products, please keep it safe & refer to it for assistance and tips.



[FiresideOutdoor.com](https://www.firesideoutdoor.com)